

Bohrstangen

S | **25** | **S** **P** | **C** | **L** | **N** | **R** | **12** | **C**

1 **2** **3** **4** **5** **6** **7** **8** **9** **10**

1 Art der Bohrstange

"A" Vollstahlausführung mit innere Kühlmittelzufuhr

"E" Hartmetallschaft mit Kopf aus Stahl und innere Kühlmittelzufuhr

"C" Hartmetallschaft mit Kopf aus Stahl ohne innere Kühlmittelzufuhr

"S" Vollstahlausführung ohne innere Kühlmittelzufuhr

2 Schaft Ø



3 Schaftlänge



A - 32	H - 100	Q - 180	x-spezial
B - 40	J - 110	R - 200	
C - 50	K - 125	S - 250	
D - 60	L - 140	T - 300	
E - 70	M - 150	U - 350	
F - 80	N - 160	V - 400	
G - 90	P - 170	W - 450	

4 Art der Schneideplattenbefestigung

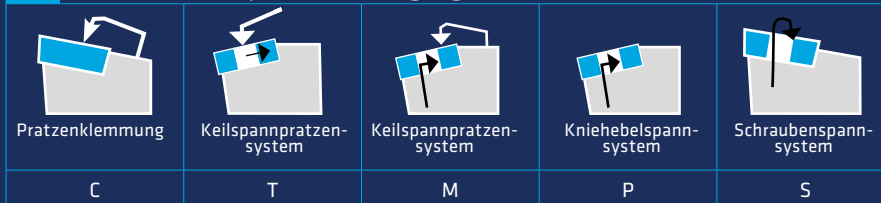

5 Plattenform

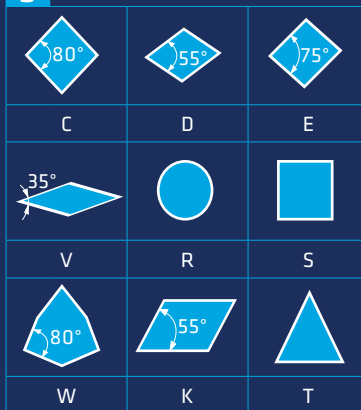

6 Anstellwinkel

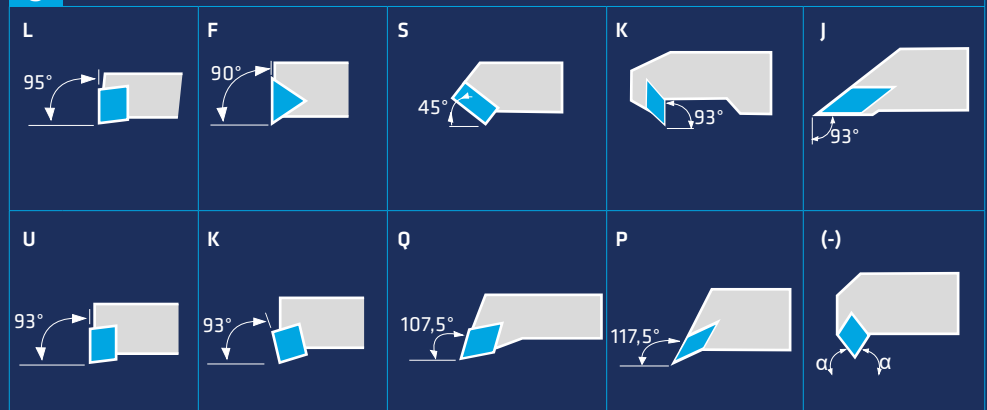

7 Freiwinkel

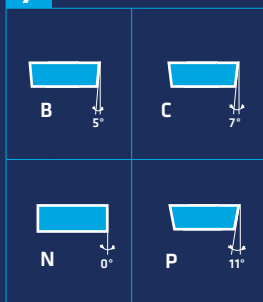

8 Halterausführung

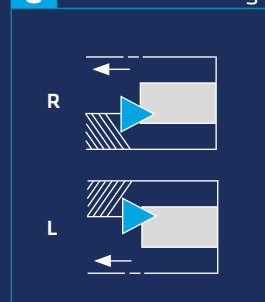

9 Schneidkantenlänge

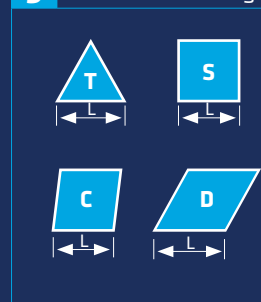

10 Spannpratze

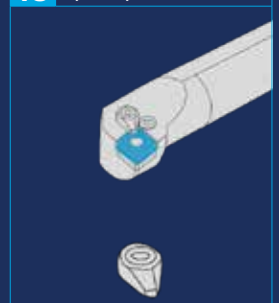

Bestellen Sie per Mail info@assfalg-metall.de oder per Telefon 07171 9250-0 unter Angabe der Ziffern 1-10.

Bohrstangen

zu Wendeplatte CNM.1204..

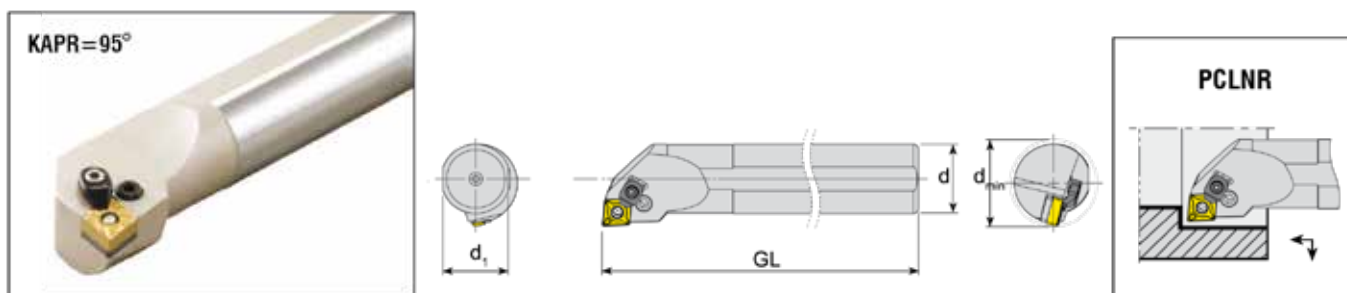

Bezeichnung	d	d ₁	GL	d _{min}	Wendeplatten	Art.-Nr.	Preis [€]
S25S PCLNR 12C	25	23	250	≥32	CNM.1204..	72207	69,00
S32T PCLNR 12C	32	30	300	≥40	CNM.1204..	73305	85,00

zu Wendeplatte CC.T 0602..

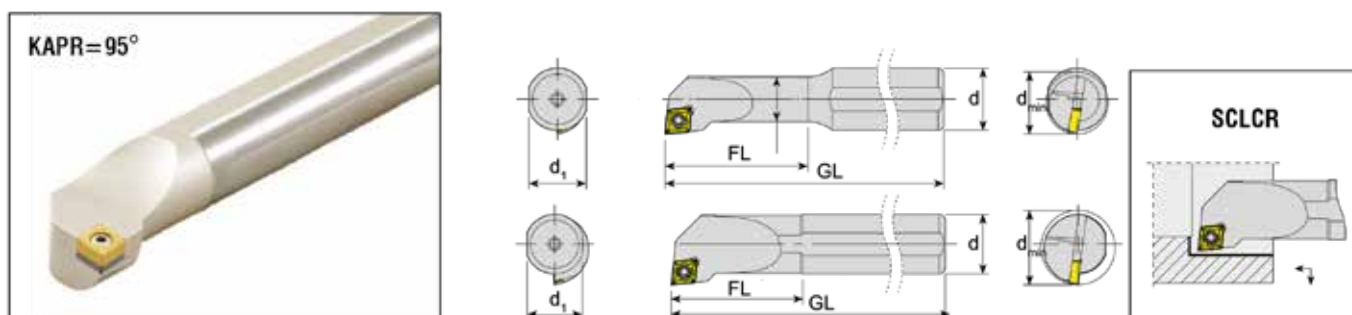

Bezeichnung	d	d ₁	FL	GL	d _{min}	Wendeplatten	Art.-Nr.	Preis [€]
S10K SCLCR 06	10	09	25	125	≥32	CC.T 0602..	48521	27,00
S12K SCLCR 06	12	11	25	125	≥16	CC.T 0602..	50572	29,00

* Weitere Ausführungen auf Anfrage

Bohrstangen

zu Wendeplatte DC.T 0702.. | DC.T 11T3..

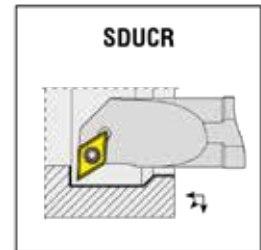
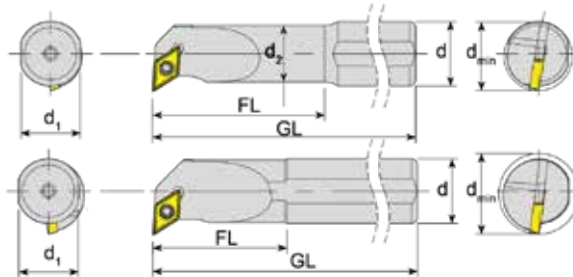

Bezeichnung	d	d ₂	d ₁	FL	GL	d _{min}	Wendeplatten	Art.-Nr.	Preis [€]
S0810K SDUCR 07	10	8	09	30	125	≥13	DC.T 0702..	29852	28,00
S10K SDUCR 07	10	10	09	25	125	≥13	DC.T 0702..	18798	27,00
S12K SDUCR 07	12	12	11	25	125	≥16	DC.T 0702..	21363	29,00
S16P SDUCR 11	16	16	14,8	35	170	≥20	DC.T 11T3..	19194	34,00
S20R SDUCR 11	20	20	18,3	40	200	≥25	DC.T 11T3..	47300	35,00
S25S SDUCR 11	25	25	23	50	250	≥32	DC.T 11T3..	15970	47,00

zu Wendeplatte DC.T 0702.. | DC.T 11T3..

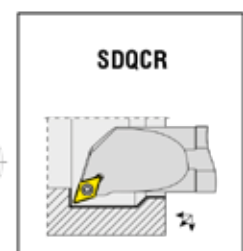
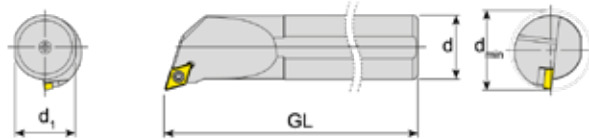

Bezeichnung	d	d ₁	GL	d _{min}	Wendeplatten	Art.-Nr.	Preis [€]
S10K SDQCR 07	10	09	125	≥13	DC.T 0702..	50085	27,00
S12K SDQCR 07	12	11	125	≥16	DC.T 0702..	47332	29,00
S16P SDQCR 07	16	14,8	170	≥20	DC.T 0702..	50115	34,00
S20R SDQCR 11	20	18,3	200	≥25	DC.T 11T3..	50117	35,00
S25S SDQCR 11	25	23	250	≥32	DC.T 11T3..	50118	47,00
S32T SDQCR 11	32	30	300	≥40	DC.T 11T3..	52712	72,00